



DC150-12 DEEP CYCLE

150AH @ 20Hr
12-Volt

Group Size: GC12

Maintenance-Free
Sealed AGM Battery

CYCLING CAPACITY

20 Hour Rate **150 Amp Hours**

RESERVE CAPACITY

@25 AMPS **295 Min** @56 AMPS **115 Min** @75 AMPS **80 Min**

ELECTRICAL SPECIFICATIONS

Nominal Voltage	12 Volt
C100	165AH
C20	150AH
C10	142AH
C5	130AH
CCA	900
CA or MCA	1050
HPCA	2000 Amps
Internal Resistance	2.3m Ω

MECHANICAL SPECIFICATIONS

Group Size	GC12	
Terminal Type	M8 with TP08 Brass AP	
Terminal Torque	See reverse side	
Height (w/ terminal)	11.57"	294mm
Height (case only)	10.51"	267mm
Width	7.17"	182mm
Length	12.87"	327mm
Weight	93.92 lbs	42.6 kg
Case Type	ABS Plastic - Flame Res. Rating UL94-HB	

DISCHARGE TABLE (Constant Current)

Time	Amps	Rate
20hr	7.5	0.05CA
10hr	13.5	0.10CA
8hr	16.3	0.13CA
5hr	24.0	0.25CA
3hr	34.0	0.33CA
2hr	51.2	0.50CA
1hr	85.5	1.00CA

DISCHARGE PROFILE (Constant Current)

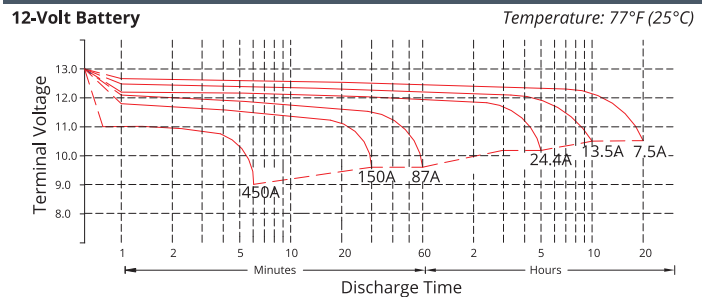

- All listed ratings are @ 100% SoC, T=77°F (25°C), 1.75VPC unless otherwise specified.

- Specifications listed are for estimation purposes only. Battery performance can vary depending on application. Battery design subject to change.

BATTERY & TERMINAL DIMENSIONS (All units shown in mm)

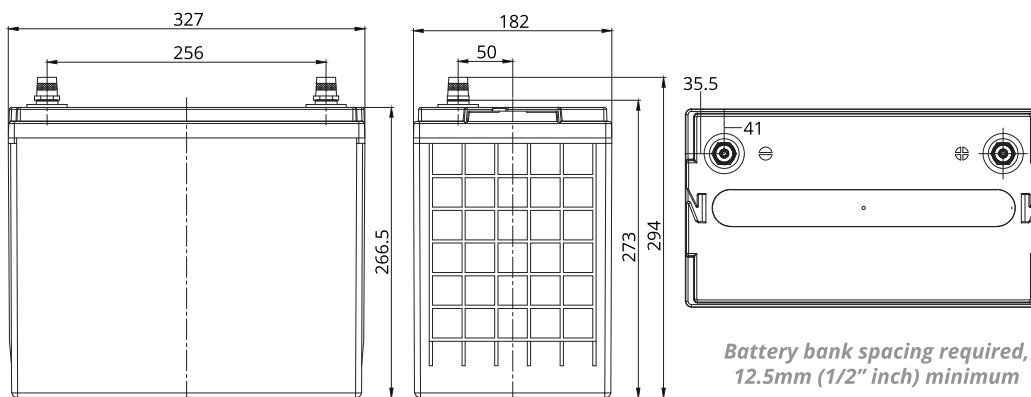

Terminal: M8 with TP08 Brass AP

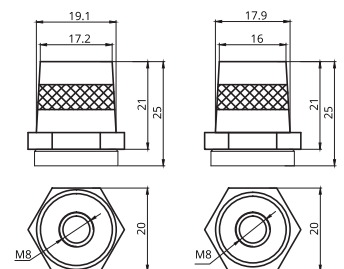

(unit: mm)



DC150-12 DATA SHEET

fullriverbattery.com

TEMPERATURE vs CAPACITY

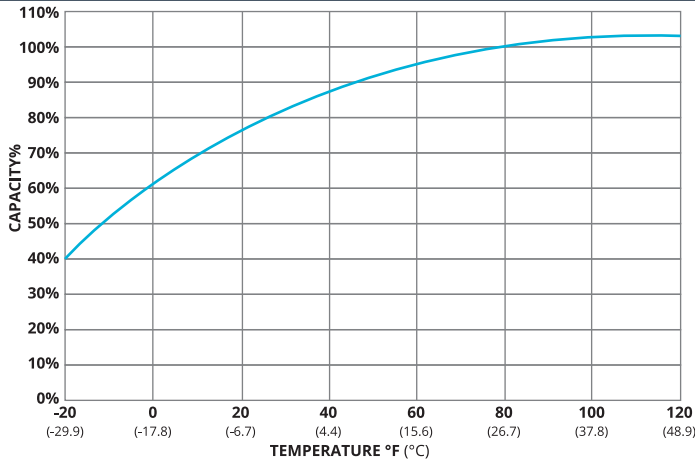

STATE of CHARGE (SOC) vs OPEN CIRCUIT VOLTAGE (OCV)

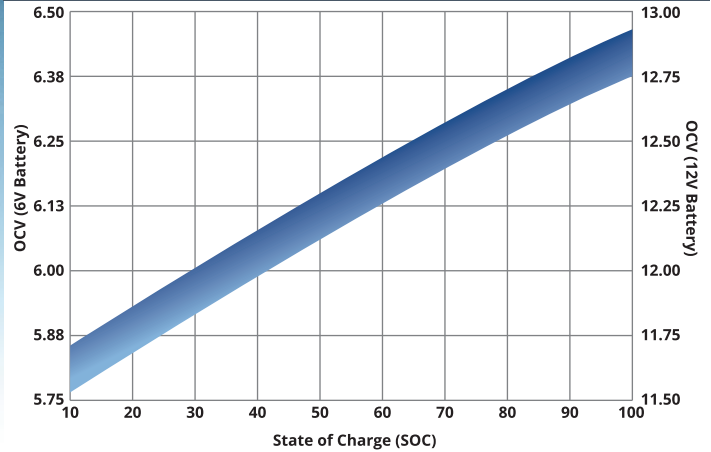

CYCLE LIFE vs DEPTH of DISCHARGE (DOD)

*(Based on BCI Testing @ 2-hr Rate)

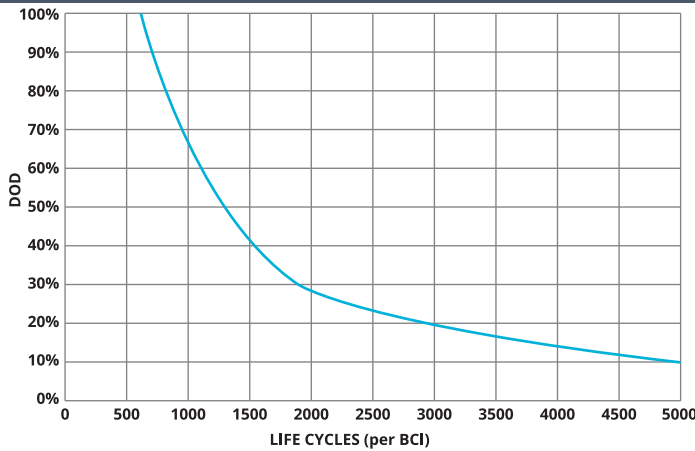

SELF DISCHARGE vs TIME/TEMPERATURE

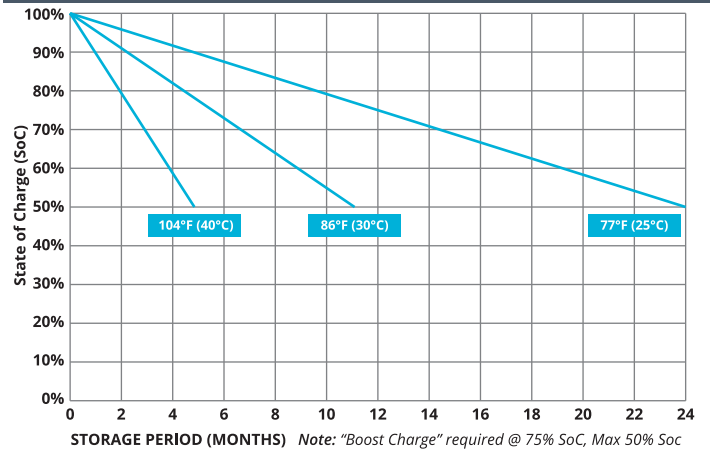

TEMPERATURE RANGE SPECIFICATIONS

Condition	Recommended	Maximum	Recommended	Maximum
Storage	5°F to 122°F	-40°F to 160°F	-15°C to 50°C	-40°C to 71°C
Operation	5°F to 104°F	-40°F to 160°F	-15°C to 40°C	-40°C to 71°C
Charge with TC	5°F to 122°F	-40°F to 160°F	-15°C to 50°C	-40°C to 71°C
Charge w/o TC	32°F to 104°F	5°F to 122°F	0°C to 40°C	-15°C to 50°C

*TC= Temperature Compensation

CHARGE VOLTAGES

Charge Stage	Battery Voltages			
	12V	24V	36V	48V
Bulk	14.7V	29.4V	44.1V	58.8V
Absorption	14.7V	29.4V	44.1V	58.8V
Float	13.6V	27.2V	40.8V	54.6V

TC Factor: (-2mV°F/cell) or (-4mV°C/cell)

TERMINAL TORQUE SPECS

Terminal Type	ft-lbs	in-lbs	Nm
AP, DT (AP), M6, M6M (Stud), TP07 (AP), TP08 (AP)	4.2 - 6.0	50-70	5.6 - 7.9
FR45	6.0 - 7.5	70-90	7.9 - 10.1
M8	7.1 - 8.0	85-95	9.6 - 10.7
DT (Stud), M10M (Stud)	9.2 - 10.4	110-125	12.2 - 14



9001:2008 Quality Management System
 14001:2004 Environmental Management System
 18001:2007 Occupational Health & Safety Management System



DELIVERY APPROVED!
**LAND, SEA
 & AIR**

Fullriver batteries are sealed lead acid batteries made with Absorbed Glass Mat (AGM) technology. The electrolyte is absorbed into the fiberglass separator material rather than in a free-flowing liquid form. Fullriver batteries are non-spillable electric storage batteries. They are excepted from the requirements of DOT's hazardous materials regulations, since they adhere to the requirements of code 49 CFR Section 173.159(D) - (CLASSIFIED APPROVED: DOT, CFR, HMR49, IATA, ICAO67, IMDG27)