



# DC245-6

## DEEP CYCLE

245AH @ 20Hr  
6-Volt

Group Size: DIN

Maintenance-Free  
Sealed AGM Battery

### CYCLING CAPACITY

20 Hour Rate **245 Amp Hours**

### RESERVE CAPACITY

Reserve @25 AMPS **457 Minutes** Reserve @75 AMPS **120 Minutes**

### ELECTRICAL SPECIFICATIONS

Nominal Voltage	<b>6 Volt</b>
C100	<b>270AH</b>
C20	<b>245AH</b>
C10	<b>221AH</b>
C5	<b>198AH</b>
CCA	<b>930</b>
CA or MCA	<b>1120</b>
HPCA	<b>2000 Amps</b>
Internal Resistance	<b>1.4m Ω</b>

### MECHANICAL SPECIFICATIONS

Group Size	<b>DIN</b>	
Terminal Type	<b>AP</b>	
Terminal Torque	<b>See reverse side</b>	
Height (w/ terminal)	<b>10.83"</b>	<b>275mm</b>
Height (case only)	<b>10.83"</b>	<b>275mm</b>
Width	<b>7.48"</b>	<b>190mm</b>
Length	<b>9.61"</b>	<b>244mm</b>
Weight	<b>71.2 lbs.</b>	<b>32.3 kg</b>
Case Type	<b>ABS Plastic - Flame Res. Rating UL94-HB</b>	

### DISCHARGE TABLE (Constant Current)

Time	Amps	Rate
20hr	12.3	0.05CA
10hr	22.1	0.10CA
8hr	24.9	0.13CA
5hr	39.6	0.25CA
3hr	55.4	0.33CA
2hr	74.9	0.50CA
1hr	137	1.00CA

### DISCHARGE PROFILE (Constant Current)

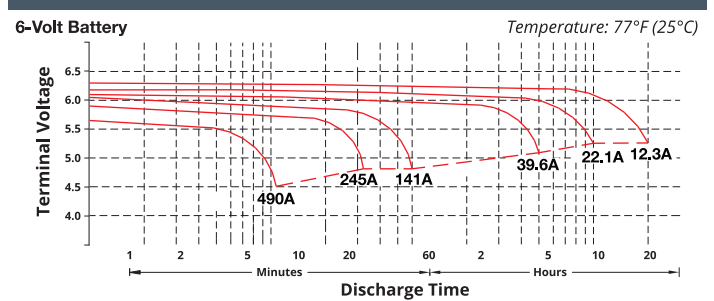

- All listed ratings are @ 100% SoC, T=77°F (25°C), 1.75VPC unless otherwise specified.

- Specifications listed are for estimation purposes only. Battery performance can vary depending on application. Battery design subject to change.

### BATTERY & TERMINAL DIMENSIONS (All units shown in mm)

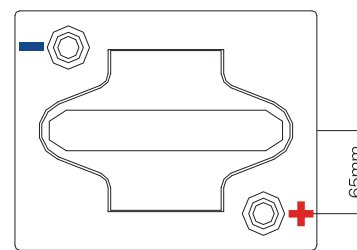
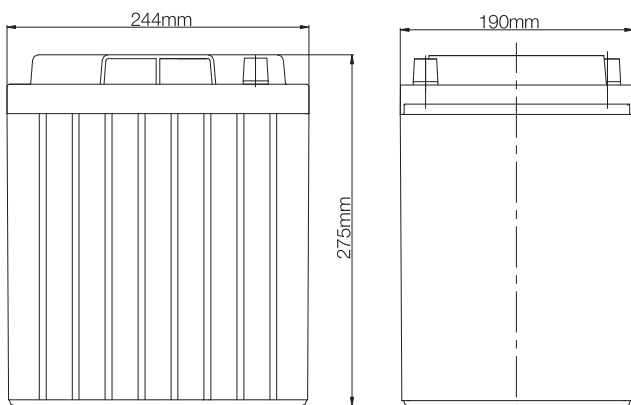

Battery bank spacing required,  
12.5mm (1/2" inch) minimum

### Terminal: AP

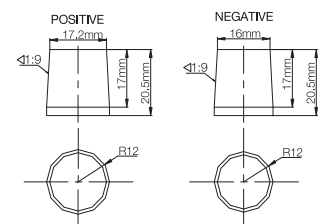

(unit: mm)



# DC245-6 DATA SHEET

fullriverbattery.com

## TEMPERATURE vs CAPACITY



## STATE of CHARGE (SOC) vs OPEN CIRCUIT VOLTAGE (OCV)

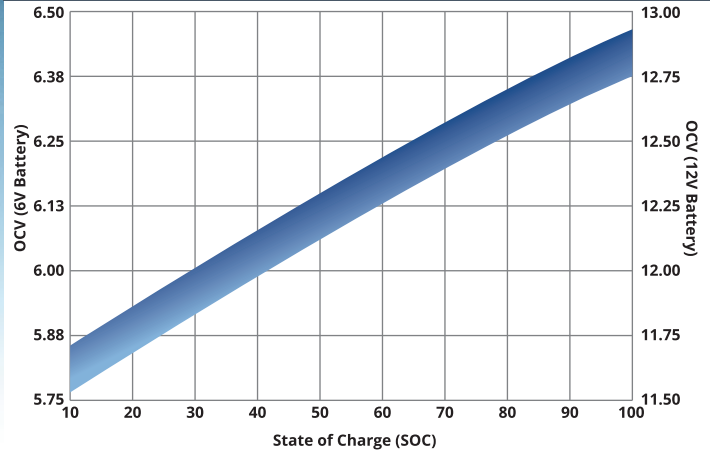

## CYCLE LIFE vs DEPTH of DISCHARGE (DOD)

\*(Based on BCI Testing @ 2-hr Rate)

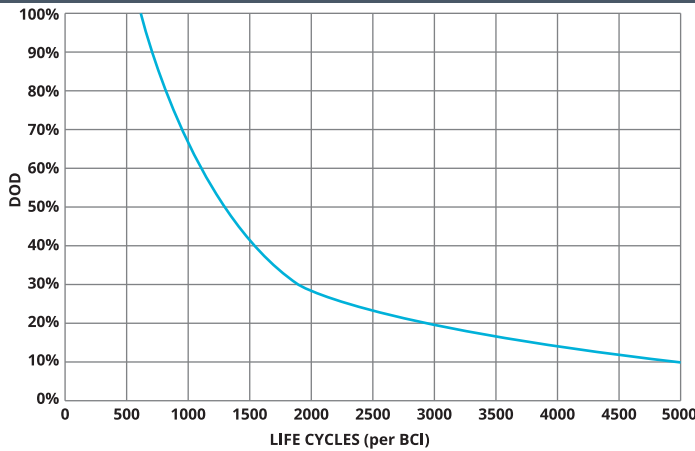

## SELF DISCHARGE vs TIME/TEMPERATURE

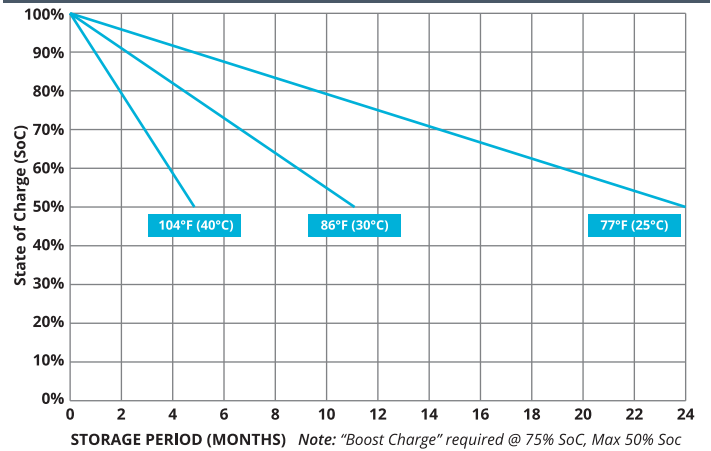

## TEMPERATURE RANGE SPECIFICATIONS

Condition	Recommended	Maximum	Recommended	Maximum
Storage	5°F to 122°F	-40°F to 160°F	-15°C to 50°C	-40°C to 71°C
Operation	5°F to 104°F	-40°F to 160°F	-15°C to 40°C	-40°C to 71°C
Charge with TC	5°F to 122°F	-40°F to 160°F	-15°C to 50°C	-40°C to 71°C
Charge w/o TC	32°F to 104°F	5°F to 122°F	0°C to 40°C	-15°C to 50°C

\*TC= Temperature Compensation

## CHARGE VOLTAGES

Charge Stage	Battery Voltages			
	12V	24V	36V	48V
Bulk	14.7V	29.4V	44.1V	58.8V
Absorption	14.7V	29.4V	44.1V	58.8V
Float	13.6V	27.2V	40.8V	54.6V

TC Factor: (-2mV°F/cell) or (-4mV°C/cell)

## TERMINAL TORQUE SPECS

Terminal Type	ft-lbs	in-lbs	Nm
AP, DT (AP), M6, M6M (Stud), TP07 (AP), TP08 (AP)	4.2 - 6.0	50-70	5.6 - 7.9
FR45	6.0 - 7.5	70-90	7.9 - 10.1
M8	7.1 - 8.0	85-95	9.6 - 10.7
DT (Stud), M10M (Stud)	9.2 - 10.4	110-125	12.2 - 14



9001:2008 Quality Management System  
 14001:2004 Environmental Management System  
 18001:2007 Occupational Health & Safety Management System



DELIVERY APPROVED!  
**LAND, SEA  
 & AIR**

Fullriver batteries are sealed lead acid batteries made with Absorbed Glass Mat (AGM) technology. The electrolyte is absorbed into the fiberglass separator material rather than in a free-flowing liquid form. Fullriver batteries are non-spillable electric storage batteries. They are excepted from the requirements of DOT's hazardous materials regulations, since they adhere to the requirements of code 49 CFR Section 173.159(D) - (CLASSIFIED APPROVED: DOT, CFR, HMR49, IATA, ICAO67, IMDG27)